

NAME:

1. Name the sources of water

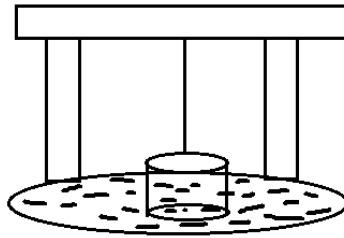
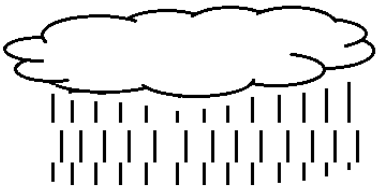

(well, river, rain)

2. Name the physical features

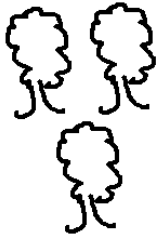

(valley, forest, mountain)

3. Name the means of transport

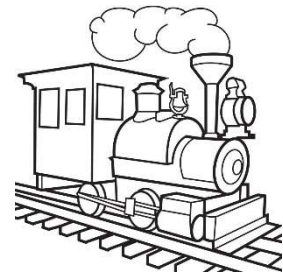
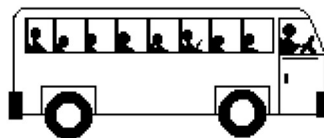
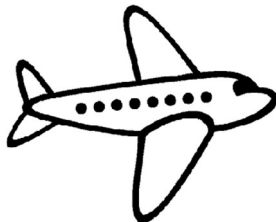
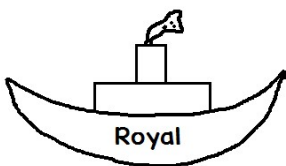

(bus, aeroplane, ship, train)

NAME:

4. Colour the traffic lights

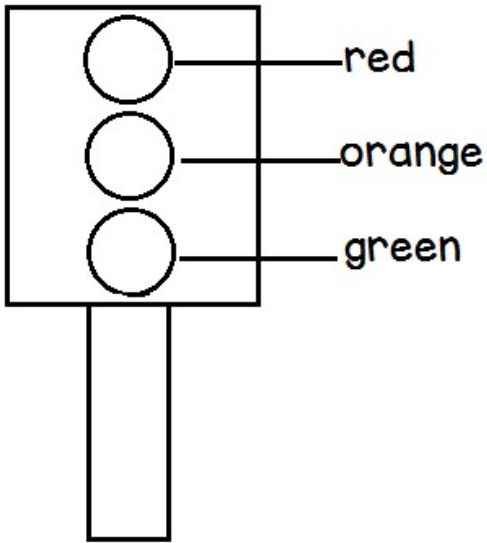

5. Name the food we eat







(beans, yam, meat)

NAME:

6. Colour the national flag

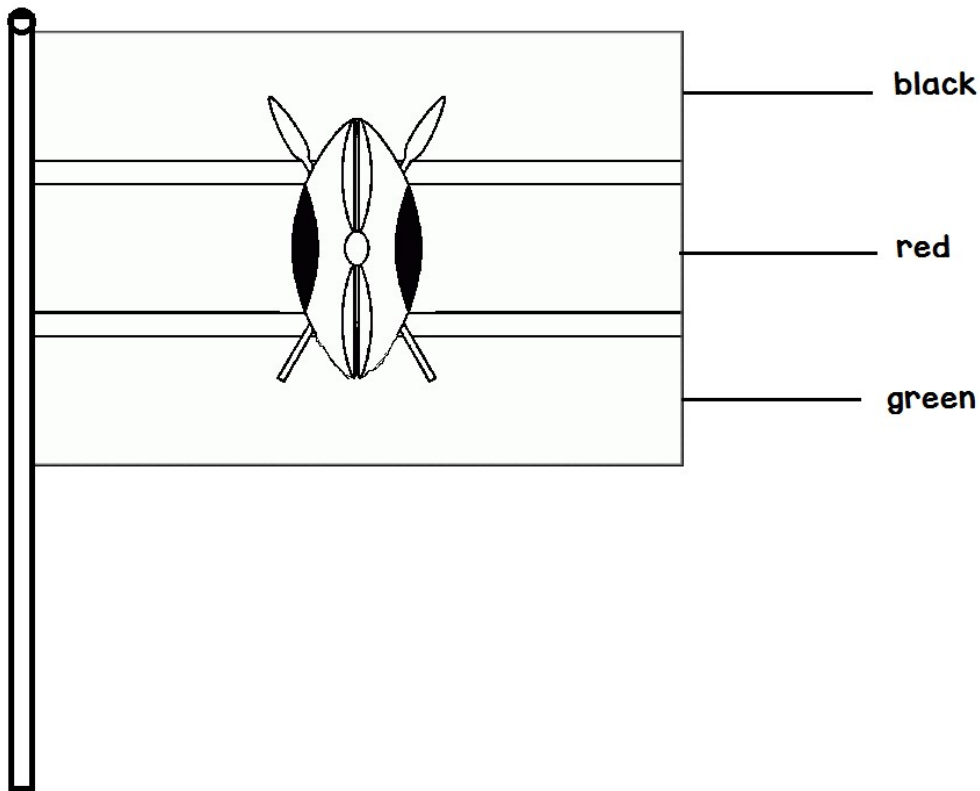

7. We go to church on _____ (Friday, Sunday)

8. God created  _____ and  _____

9. The mother of Jesus was called _____ (Lucy, Mary)